

Система охлаждения для компьютера.

Модель: S93+

Изготовитель и его адрес: Shenzhen Fluence Technology PLC(China)

A701 1# Bulding A,LongGang TianAn Cyber Innovation Park.

Страна производства: Китай

Импортер: ООО "Онлайн Трейдинг"

117042,г.Москва,ул.Академика Понрягина,д.21,корп.1

Тел./Факс: +7(495)663-31-95

Срок гарантии 1 год,Срок службы 3 года

PCCOOLER®

f | @PCCoolerOC3

www.pccooler.com | Q

S  
SERIES

INSTALLATION

正面

正反印刷  
居中对折

COMPONENTS

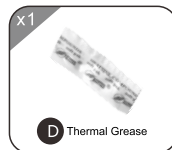
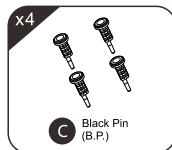
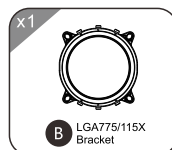
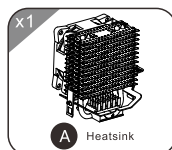

ATTENTION

1. Push the adjustable button on the bracket.
2. Button's left side is use for 775, the right side is use for 115X

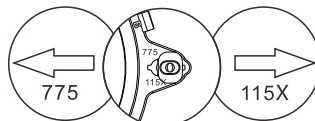

WARNING

- Be careful of the sharp fin edges to avoid injury
- Keep away from children

\* The picture is only for reference, please make the object as the standard.

For Intel LGA775/115X

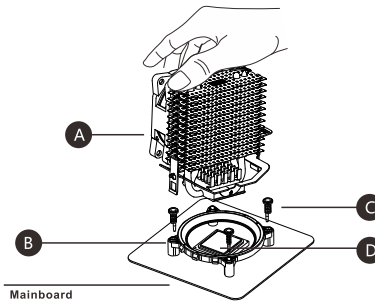

For AMD up to AM4

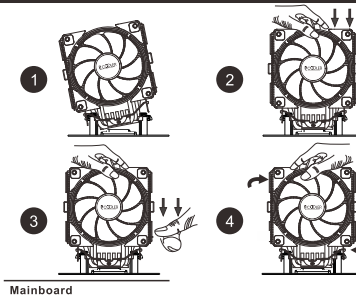

反面

正反印刷  
居中对折